

XOXO

Thinking
Works
Guiniah!

Design and Engineering Team



Introducing XOXO

Created by the award-winning teams at Thinking Works & Square Bear Acoustics, the XOXO Modular Lounge is the result of a collaboration between talented designers and skilled craftsmen.

This innovative system seamlessly integrates traditional soft seating with fast-paced modern workplaces and public spaces, delivering ergonomic comfort, contemporary style, and versatile seating arrangements for dynamic environments.

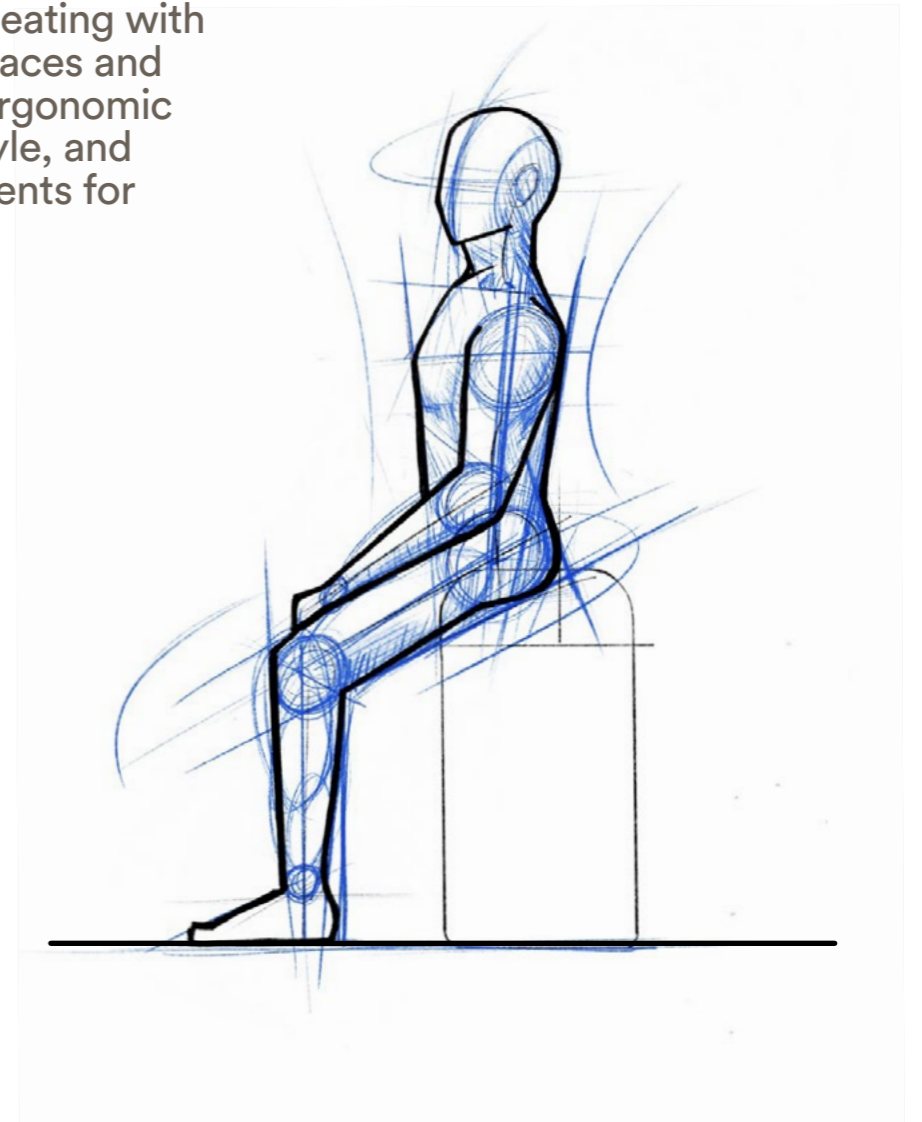

Ergonomic & Soft Seating Design for versatility

Dean Kuch

Managing Director of Thinking Works & Square Bear Acoustics

What was the starting point for developing XOXO?

Through conversations with interior designers and furniture sellers in the commercial space, we recognised a need for products that offer flexibility and adaptability in ever-changing workplaces, ones that encourage collaboration and interaction, but still allow designated areas to do so.

Why is soft seating important for today's workplace design?

Today's workplace is much more versatile than 20 years ago. Through changes in technology, the way in which we work looks completely different, and the picture of the classic office worker that sits at one desk for 8 hours has changed.

Today's workday is split up into lots of different tasks like focused work, collaborating and networking. All of these tasks require different environments, therefore, today's workplace must be loud but quiet, open but private, exciting but calm all at the same time.



We see people not only working in the office, but they also work in cafés or hotels, at home or at the airport.

As a furniture manufacturer, we need to understand the different work environments, and soft seating is a very important part of today's workspace environment and its ability to foster collaboration while promoting well-being and productivity.

What happened to ergonomic workplace design?

More movement throughout the day is important, and that's what has improved since I started working in the commercial furniture industry in the late 1980s.

Soft seating is certainly a lot more relevant and adds to the mix of workplace settings where office workers in a hybrid work environment can choose different locations for different tasks.

Ergonomic monitor arms and task chairs are very important for desk-based work, however, in a hybrid workplace where collaborative zones are more important than ever, sometimes more casual settings for collaboration and connecting people are the most appropriate and adaptable.

We recognise that soft seating for the office must be different to the couches in our homes, they must be more comfortable to work at, and at the same time, easier to sit in and get up from. That's achieved with details such as more upright seating positions and firmer upholstery foam.

Ergonomic & Soft Seating Design for versatility cont'd

Lowell Mak

Head of Design at Thinking Works & Square Bear Acoustics

What is modular design to you and why is it important?

Modular design involves creating products using standardised, interchangeable components or modules.

This design philosophy is important to us as it allows for flexibility, adaptability, and scalability, enabling users to easily reconfigure product to meet changing needs.

Additionally, it is beneficial for us as a manufacturer as it promotes streamlined production processes, reducing manufacturing costs, lead times and enhancing overall efficiency.

How important is it to reconfigure workspaces?

A modular approach allows for inclusivity, accommodating different needs and preferences, whether for collaborative work, relaxation, or focused tasks.

Modular systems are often a more cost-effective solution as they can be easily reconfigured and adapted.





**Designed to Connect:
Sitting, Perching, People**

Craftmanship In-house

The Makers

Creating XOXO required seamless collaboration between Thinking Works design, joinery and upholstery teams, with each group bringing their own unique expertise to the product. Throughout the development of XOXO, the teams refined the structure and upholstery to achieve a cohesive look.

Our CNC machining and joinery team efficiently craft XOXO understructures, producing only what's needed per order. This reduces waste, shortens lead times, and ensures faster delivery. With full control over production, we maintain higher quality, guaranteeing durability and a high-quality product — something that is more difficult to achieve when using external suppliers.

All XOXO pieces are upholstered by our talented and experienced in-house team. Each piece of fabric is expertly sewn, carefully fitted, and checked thoroughly to ensure it meets Thinking Work's high standards. This attention to detail guarantees that our products not only look great but also stand the test of time.

XOXO is designed and constructed with durability in mind by our talented family of craftspeople. With quality control protocols at each step of production, this ensures XOXO provides continual value to the end user by providing a robust seating-perching solution that is tough enough to withstand the rigours of a commercial space.





XOXO

Meet the Range

01 **Seating**
450mm sitting height
6 different modules
Page 16-27

02 **Perching**
680mm perching height
5 different modules
Page 28-37

Australian Made
Designed and manufactured in
Sydney, Australia

www.thinkingw.com

Warranty
7 year structural warranty

XOXO transforms workplaces into inviting collaboration zones where ideas and inspiration can flow freely, allowing every interaction to strengthen bonds and foster a thriving work culture.

With a mix of straight and curved modules in two heights, XOXO's playful and functional design makes it the perfect solution for creating dynamic environments for both planned or impromptu meetings where ideas can be shared.

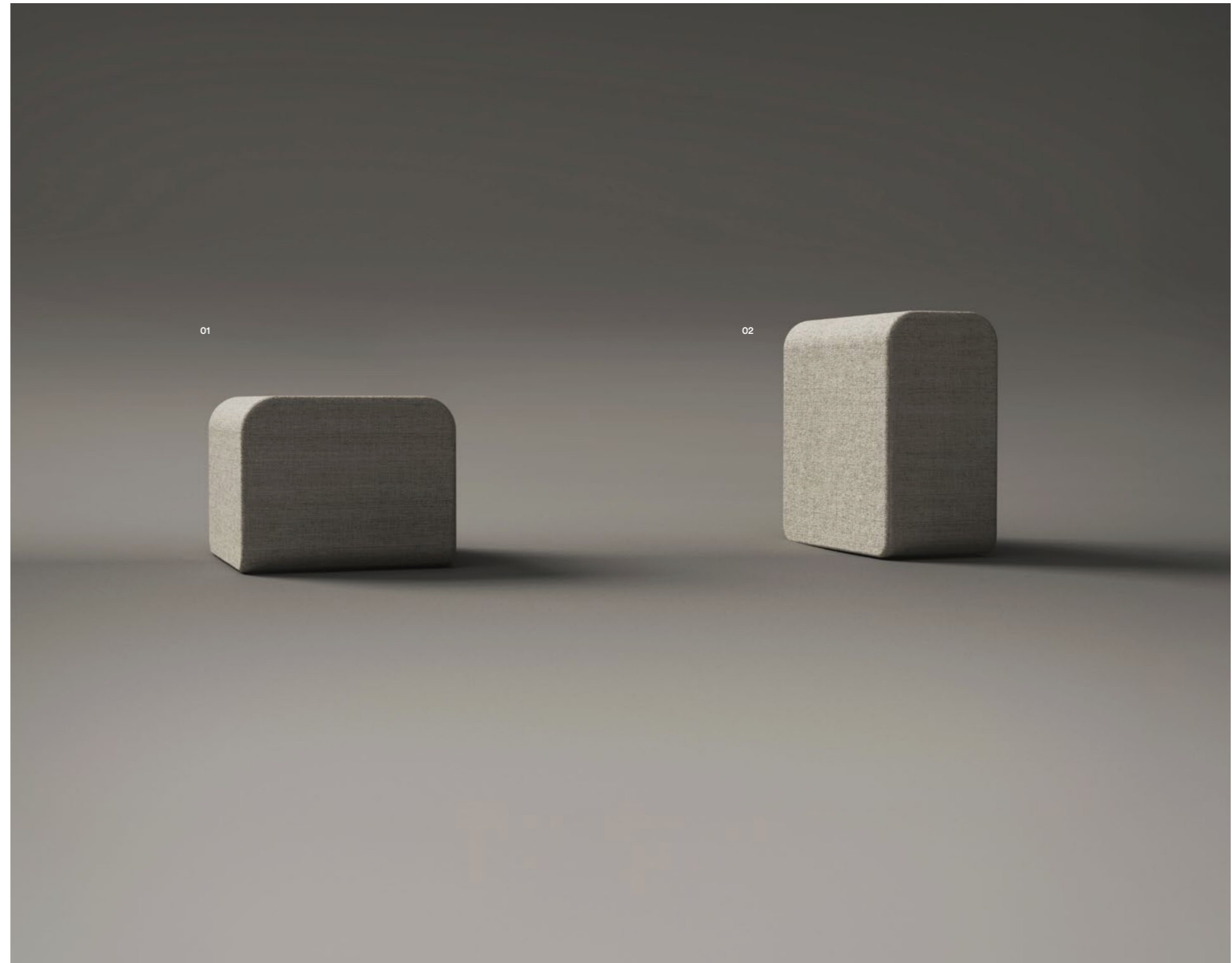



XOXO - A Truly Modular System
All XOXO modules can be freely linked front-to-back or in-line. Hidden, tool-free connections enable effortless reconfiguration of any arrangement.

XOXO Seating Range

Designed with a deep, low seat, the XOXO seating range enables customisable informal collaboration areas with connectible modules.

These modules can be linked to provide flexible options for public spaces, reception areas, and future-proof collaboration spaces.

The freedom to use them on their own or in conjunction with the Perching range belongs to the end user, making the range entirely modular.

01 **XOS-L-1100**
XOXO Loose Single Seat,
650x550x450mmH

02 **XOS-L-1200**
XOXO Loose Double Seat,
1300x550x450mmH

03 **XOS-L-1300**
XOXO Loose Inner Curve Seat,
1325x550x450mmH

04 **XOS-L-1400**
XOXO Loose Outer Curve
Seat, 1405x550x450mmH

05 **XOS-L-1600**
XOXO Loose Chicane LHS
Seat, 840x550x450mmH

06 **XOS-L-1700**
XOXO Loose Chicane RHS
Seat, 840x550x450mmH

07 **XOS-L-1800**
XOXO Small D-End Seat,
875x470x450mmH

08 **XOS-L-1900**
XOXO Large D-End Seat,
1410x735x450mmH

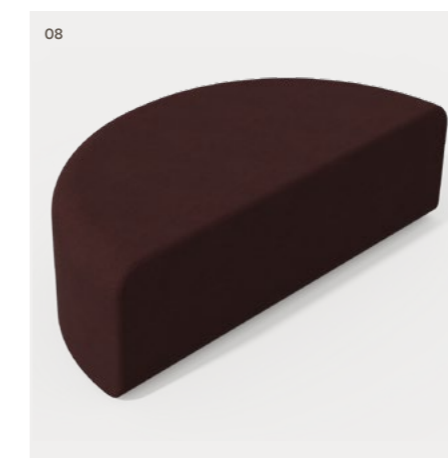



XOXO Chicane

XOXO reimagines back to back seating with the Chicane piece which switches seating from one side to the other maximizing space efficiency with fewer modules allowing the creation of separate seating zones for smaller groups.



XOXO Seating Range



XOS-L-1100
XOXO LOOSE - SINGLE SEAT

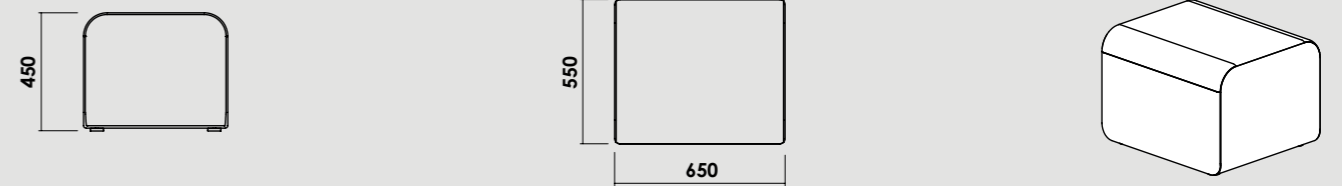

XOS-L-1200
XOXO LOOSE - DOUBLE SEAT

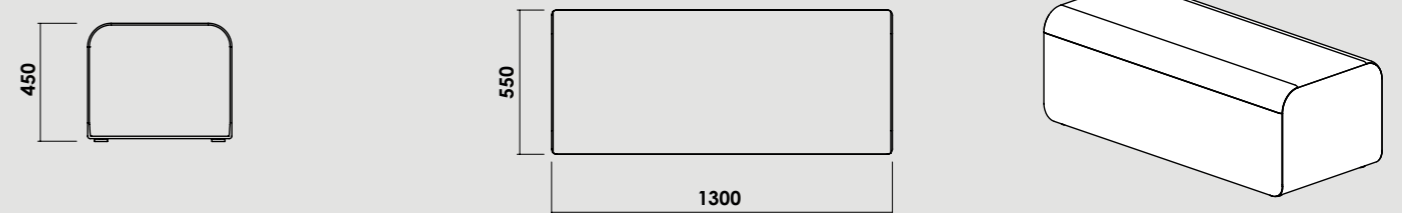

XOS-L-1300
XOXO LOOSE - INNER CURVE SEAT

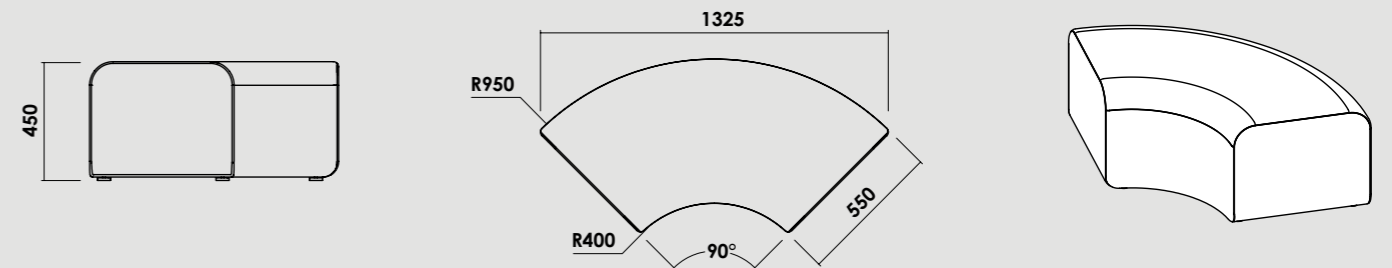





XOS-L-1400

XOXO LOOSE - OUTER CURVE SEAT

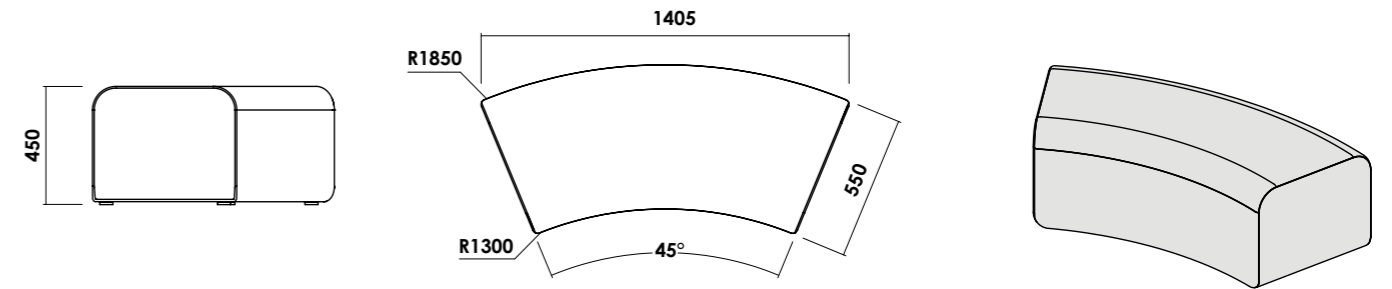

XOS-L-1600

XOXO LOOSE - CHICANE LHS SEAT

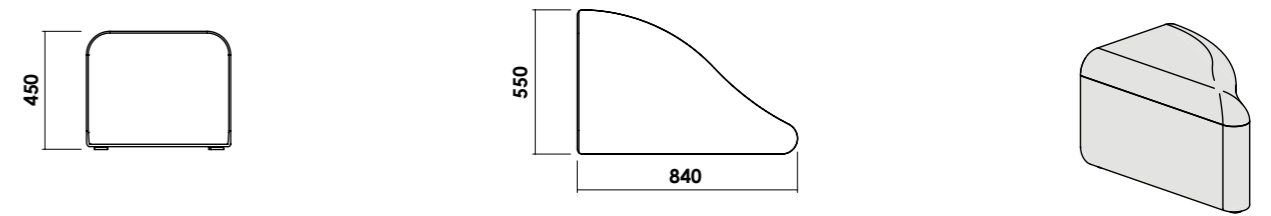

XOS-L-1700

XOXO LOOSE - CHICANE RHS SEAT

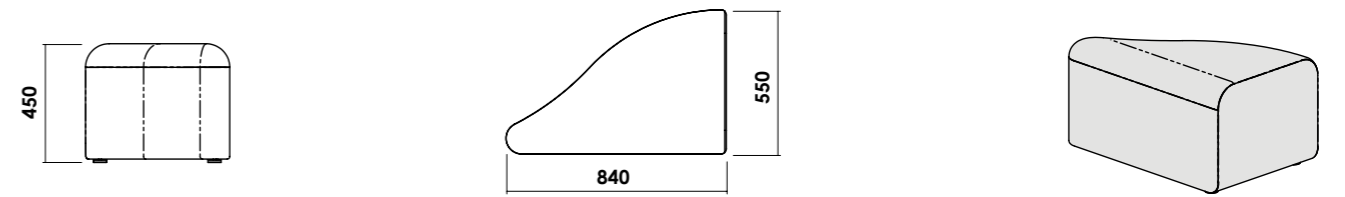





XOS-L-1800

XOXO LOOSE - SMALL D-END SEAT

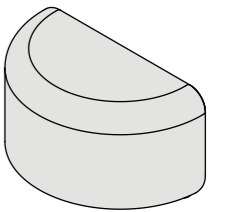
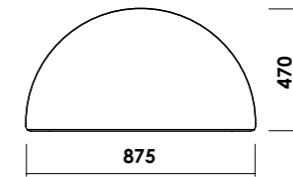
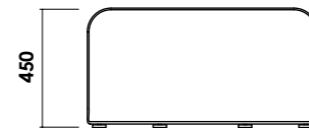

XOS-L-1900

XOXO LOOSE - LARGE D-END SEAT

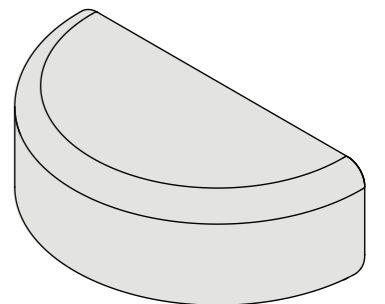
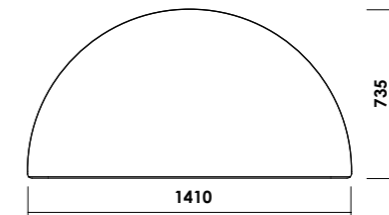

XOXO

Perching Range

Designed to promote good posture and prevent fatigue, the Perching component of XOXO provides an ergonomic solution for impromptu catch-ups and fast-paced meetings.

The typical ergonomic position of perching provides several benefits, as it opens the hips and engages the core which can protect against and provide relief from lower back pain.

The engagement of core muscles can restore strength that is lost when in traditional seated positions for long periods of time.

01 **XOS-L-2100**
XOXO Loose Single Perch,
650x350x680mmH

02 **XOS-L-2200**
XOXO Loose Double Perch,
1300x350x680mmH

03 **XOS-L-2400**
XOXO Loose 45° Corner
Perch, 985x350x680mmH

04 **XOS-L-2500**
XOXO Loose Mid Curve Perch,
1820x350x680mmH

05 **XOS-L-2600**
XOXO Loose Chicane LHS
Perch, 1300x350x680mmH

06 **XOS-L-2700**
XOXO Loose Chicane RHS
Perch, 1300x350x680mmH



XOXO Perching Range



XOS-L-2100

XOXO LOOSE - SINGLE PERCH

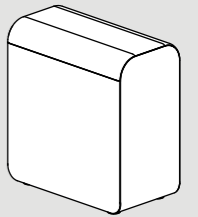
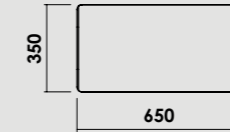
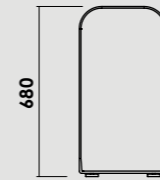

XOS-L-2200

XOXO LOOSE - DOUBLE PERCH

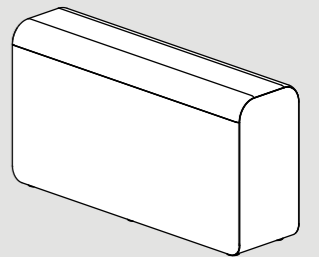
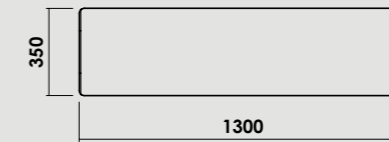
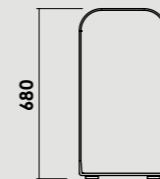

XOS-L-2400

XOXO LOOSE - 45° CORNER PERCH

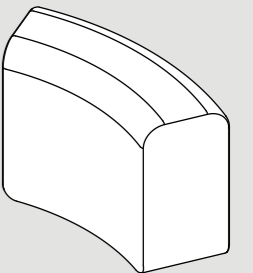
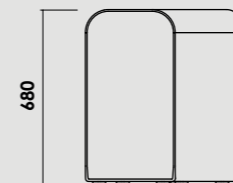



XOXO Perching Height
The XOXO modules at a 680mm perching height are designed to seamlessly pair with bar-height stools and tables, enhancing versatility and comfort in elevated table and seating arrangements.



Effortless Versatility from Every Angle
Supports flexible seating arrangements, enabling users to engage from either side, whether for collaborative or individual activities.

XOS-L-2500
XOXO LOOSE - MID CURVE PERCH

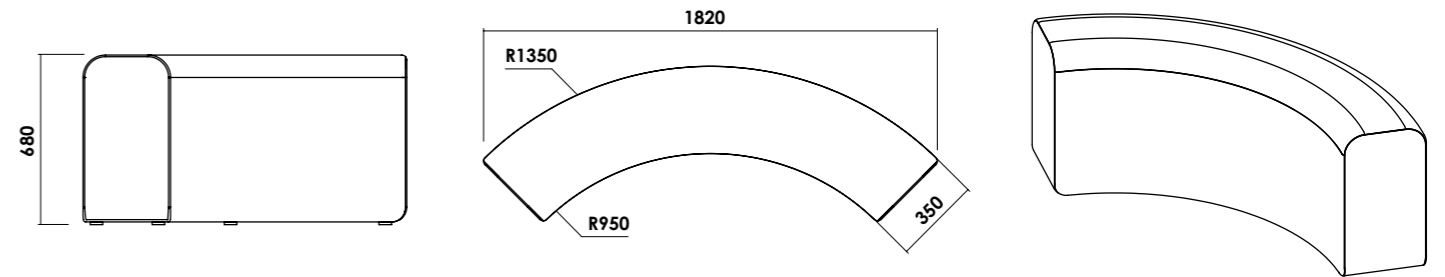

XOS-L-2600
XOXO LOOSE - CHICANE LHS PERCH

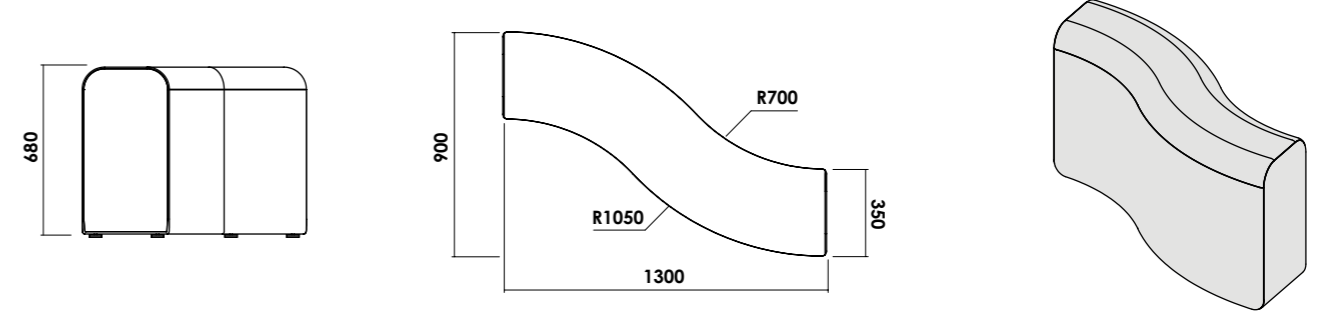

XOS-L-2700
XOXO LOOSE - CHICANE RHS PERCH

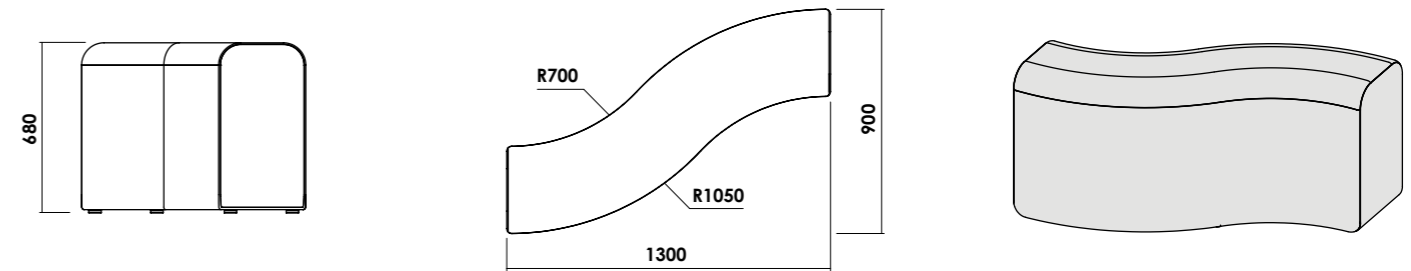



XOXO

Reconfigure through Flexible Linking

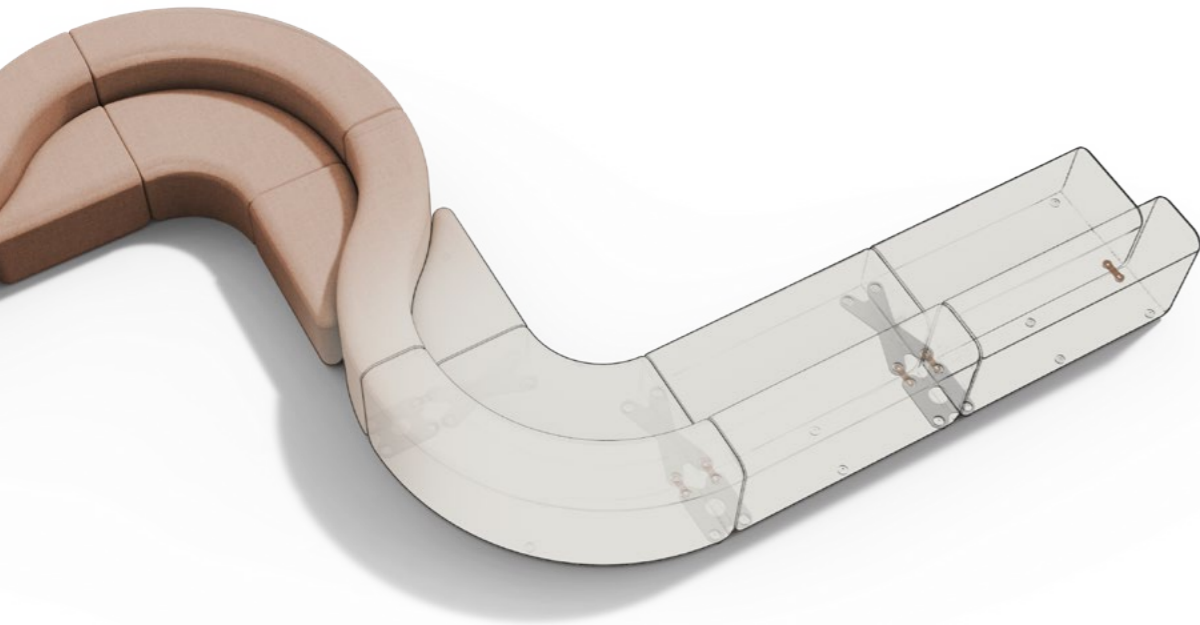

Reuse rather than Replace

The XOXO modular seating system offers three versatile connection types:

- Seat + Perch (Front to Back)
- Seat + Seat (In-Line)
- Perch + Perch (In-Line)

Each connection uses discreet, low-profile linking brackets positioned beneath the modules. These brackets lock the modules together preventing separation during use. This linking method enables effortless reconfiguration, ideal for today's dynamic work environments. XOXO modules can be rearranged without tools, adapting seamlessly to the requirements of a flexible workplace.

Modules can easily be added or removed, making XOXO a sustainable choice as it allows for reuse rather than replacement. This flexibility supports a truly modular soft seating solution built for versatility and longevity.

XOS-X-0001
SEAT + PERCH CONNECTOR

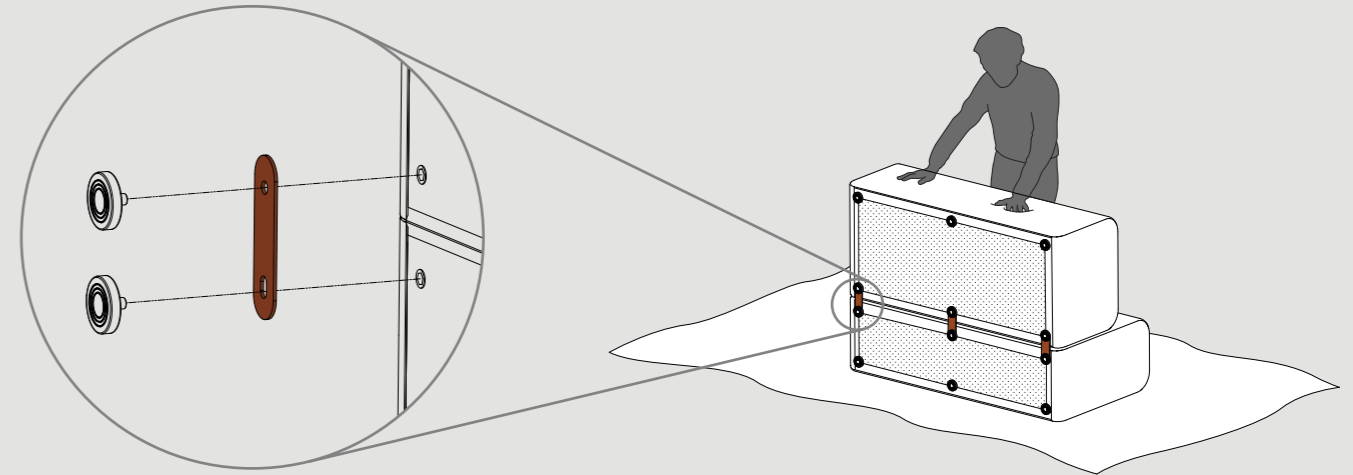

XOS-X-0003
SEAT + SEAT CONNECTOR

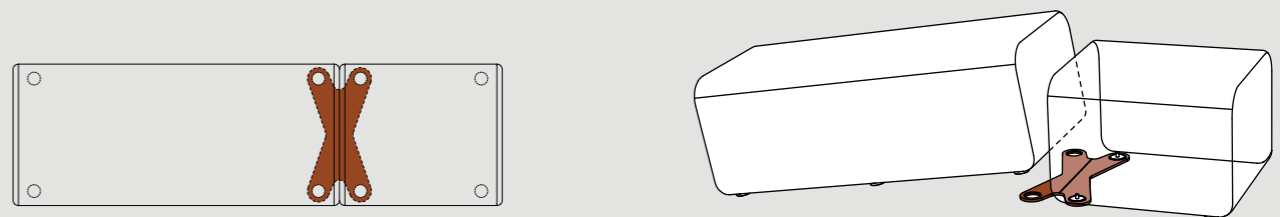

XOS-X-0004
PERCH + PERCH CONNECTOR

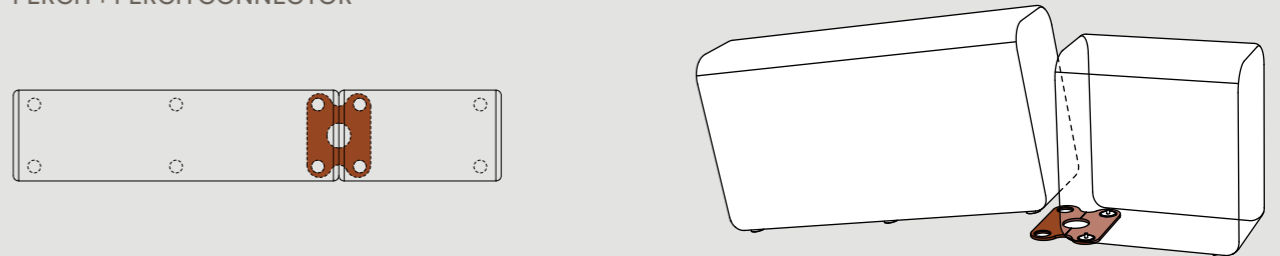



Design Support

Thinking Works in-house design support offers tailored solutions for workspace needs.

Clients benefit from direct access to our designers, receiving personalised assistance in creating custom pieces, adapting designs, or optimising layouts.

Our design team provides technical communication, including shop drawings, renderings, and installation instructions, ensuring projects align with the client's vision.

Streamlined communication accelerates timelines and guarantees high-quality results, making the design and manufacturing process smoother and more efficient.

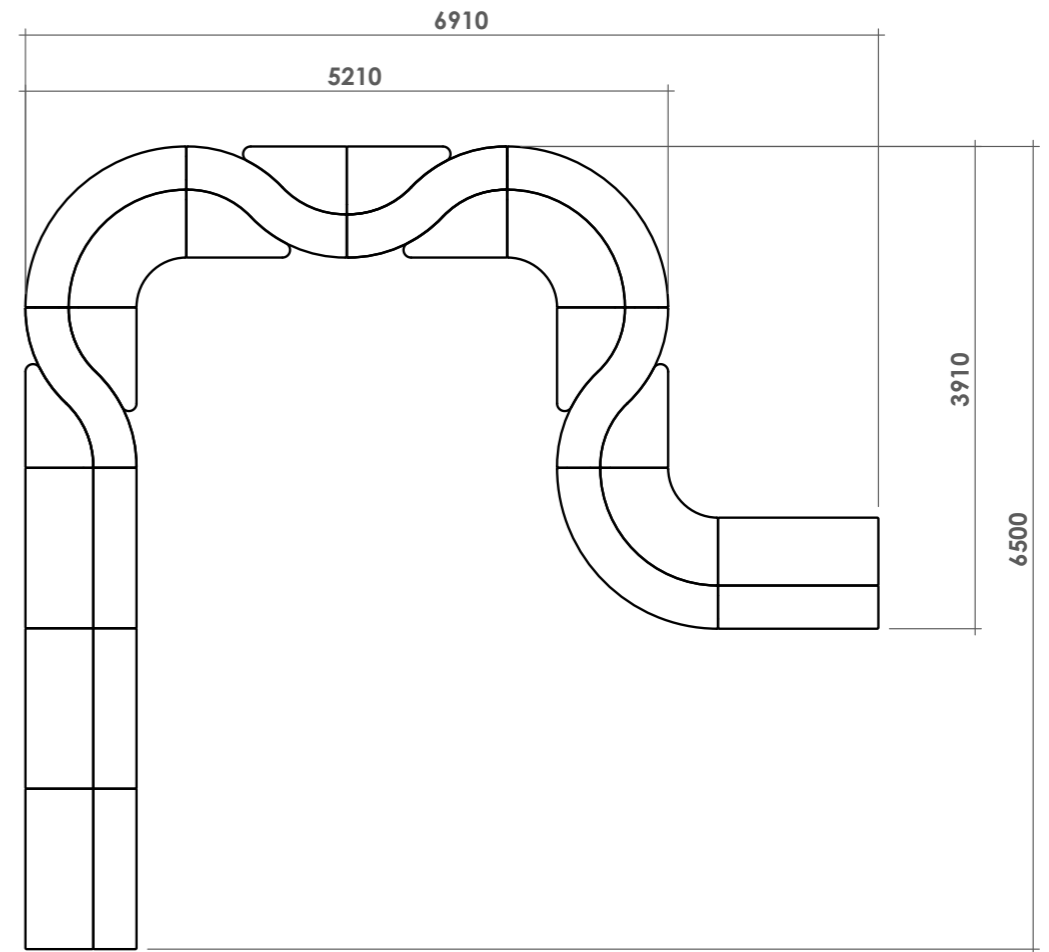
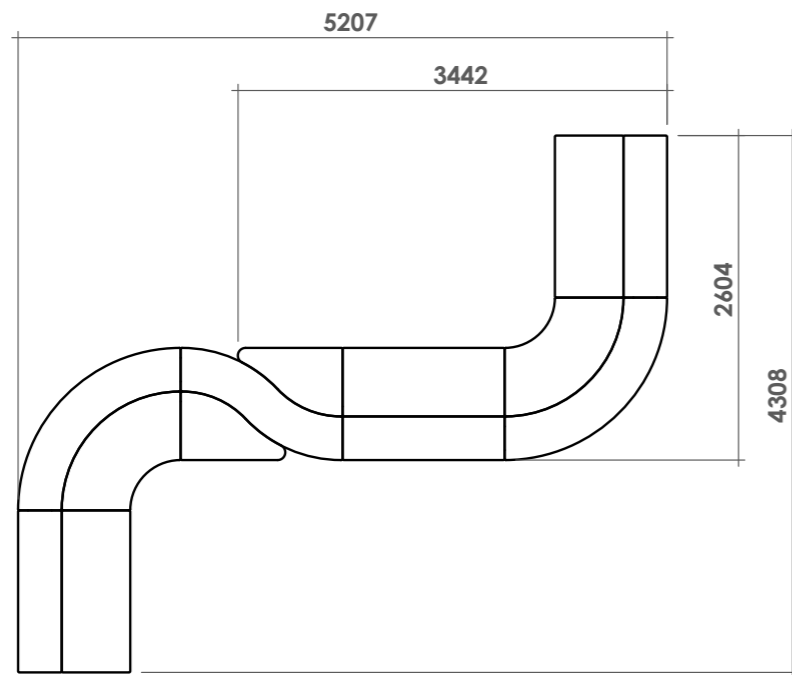

Rosie Workstation

If you would like a sample set of any of our finishes, please contact us on the details below.

Due to our policy of continuous product development, specifications and finishes may change without prior notice.

Sustainability

Our commitment to sustainability isn't driven by trends, it is guided by our belief that doing the right thing is the only way forward. From product certifications to responsible sourcing, we are committed to taking meaningful action across every part of our business. To learn more about our sustainability journey, visit the Thinking Works website or contact our Sustainability & ESG Manager using the details below.

Thinking Works

© Copyright 2025
All Rights Reserved

Head Office

Warehouse 2B/M5 Industry Park
1 Moorebank Ave, Moorebank
New South Wales 2170 Australia
P: +61 (0)2 9726 7177
F: +61 (0)2 9726 7188
sales@thinkingw.com

Australia Enquiries:

sales@thinkingw.com

New Zealand Enquiries:

sales@thinkingw.com

United Kingdom and Europe Enquiries:

exports@thinkingw.com

Middle East Enquiries

exports@thinkingw.com

Asia Enquiries:

exports@thinkingw.com

United States of America Enquiries:

exports@thinkingw.com

www.thinkingw.com