



LAUNCH

DURABLE, FUN STOOLS AND TABLES

DESIGNER
Ben McCarthy

Sunshine Coast City Council, QLD, designed by Cottee Parker

The Launch design represents a 3-pronged rocket set for launch.

The Launch stools and tables are a stackable, UV resistant virtually indestructible seating and tabletop solutions for residential, hospitality, and commercial environments.

Made from polyethylene the Launch collection are also 100% recyclable.

MODELS:

Junior: 300mm seat height

Standard: 440mm seat height

COLOURS:

Junior:

Galactic green | Star white | Cosmic red | Milky Way blue

Standard:

Galactic green | Star white | Cosmic red | Jupiter orange | Stellar pink | Asteroid black

CUSTOM OPTIONS:

Custom polyethylene colours are available on request. Stools can be fully upholstered in customer's on fabric, leather or vinyl. Minimum quantities and set-up costs apply. Stools can be permanently fixed to the ground.

LAUNCH

JUNIOR AND STANDARD SIZED STOOLS



Junior Launch Stools



Standard sized Launch Stools

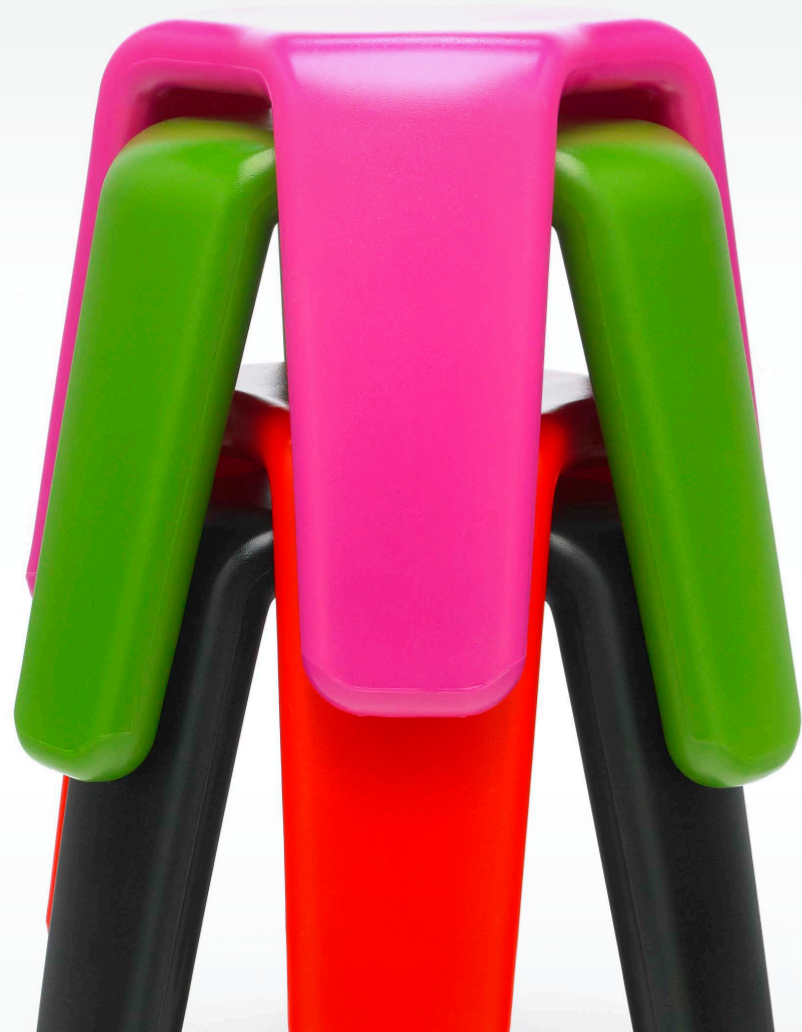

LAUNCH

TABLES



Launch Table and Stools in Star white



Launch Table and Stools in Cosmic red



Launch Table and Stools in Asteroid black

COLOURS:

Star white | Cosmic red |
Asteroid black

CUSTOM COLOUR OPTIONS:

Custom polyethylene colours are available on request. Minimum quantities and set-up costs apply.

Tables can be permanently fixed to the ground.

One single large, virtually indestructible form, the Launch table top provides a generous surface area. Its aesthetic is simple, clean and has a distinct presence for a café or outdoor environment.





LAUNCH COLLECTION - PRODUCT SPECIFICATIONS

DESIGNER: Ben McCarthy

MATERIAL AND FINISH
Recyclable UV-resistant textured polyethylene.

COLOURS

Junior Launch Stools: Galactic green | Star white | Milky Way blue | Cosmic red



Launch Stools: Galactic green | Star white | Jupiter orange | Cosmic red | Stellar pink | Asteroid black



Launch Tables: Galactic green | Asteroid black | Star white | Cosmic red



CUSTOM OPTIONS

Custom polyethylene colours are available on request. Stools can be full upholstered to customer's own requirements. Minimum quantities and set-up costs apply.

WARRANTY
5 years.

DIMENSIONS

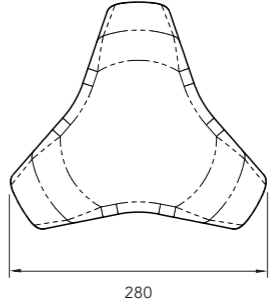
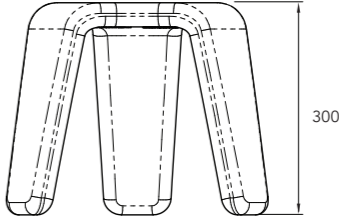

Junior Launch Stool

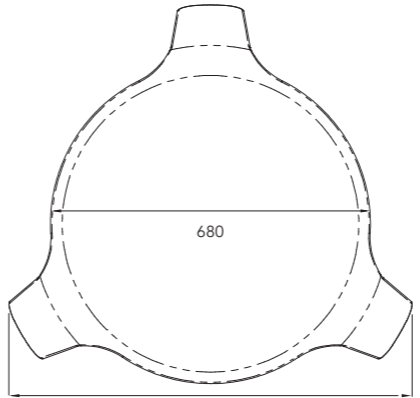
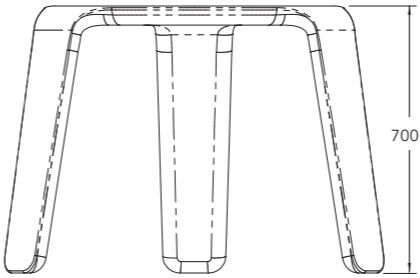

Junior Table

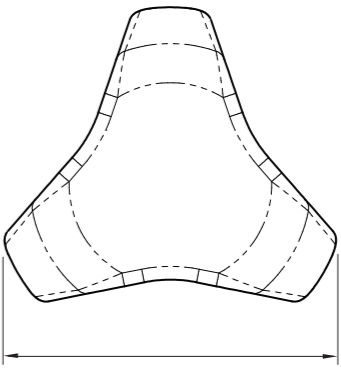
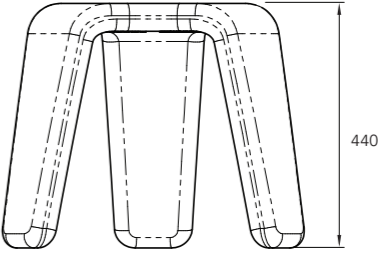

Launch Stool