

Buddy

BDT - BDTD

DESIGN
Busetti Garuti Redaelli

PEDRALI

100%
MADE IN
ITALY



EN: Coffee table with aluminum legs and a top in marble, marble agglomerate, or laminate, available in two different heights.

IT: Tavolino con gambe in alluminio e ripiano in marmo, agglomerato di marmo o stratificato disponibile in due diverse altezze.

DE: Kleintisch mit Aluminiumbeinen und einer Platte aus Marmor, Marmor-Agglomerat oder Schichtstoff, erhältlich in zwei verschiedenen Höhen.

FR: Table basse avec pieds en aluminium et plateau en marbre, aggloméré de marbre ou stratifié, disponible en deux hauteurs différentes.

ES: Mesita con patas de aluminio y encimera de mármol, aglomerado de mármol o laminado, disponible en dos alturas diferentes

mm - in

• BDT_59X59X26

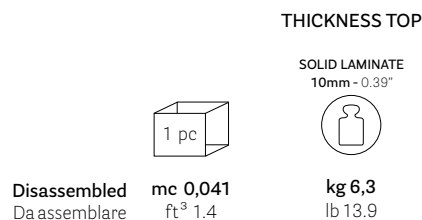

EN: Tabletop in marble or composite marble with a compact laminate support 6 mm thickness

IT: Ripiano in marmo e agglomerato di marmo con supporto in stratificato spessore 6 mm

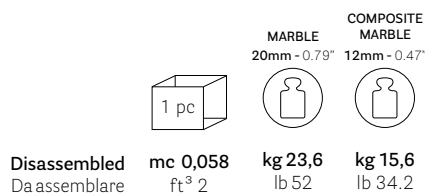
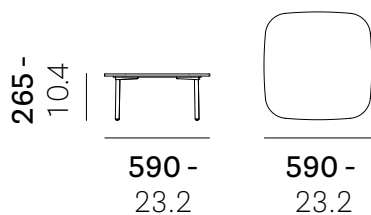

• BDT_59X59X32

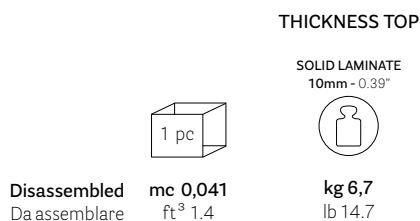
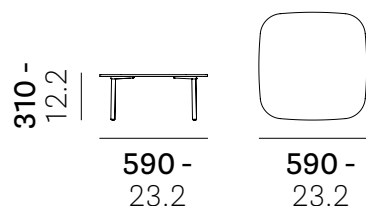

BDT - BDTD

DESIGN
Busetti Garuti Redaelli

EN: Tabletop in marble or composite marble with a compact laminate support 6 mm thickness
IT: Ripiano in marmo e agglomerato di marmo con supporto in stratificato spessore 6 mm



• BDT_79X79X26



EN: Tabletop in marble or composite marble with a compact laminate support 6 mm thickness
IT: Ripiano in marmo e agglomerato di marmo con supporto in stratificato spessore 6 mm

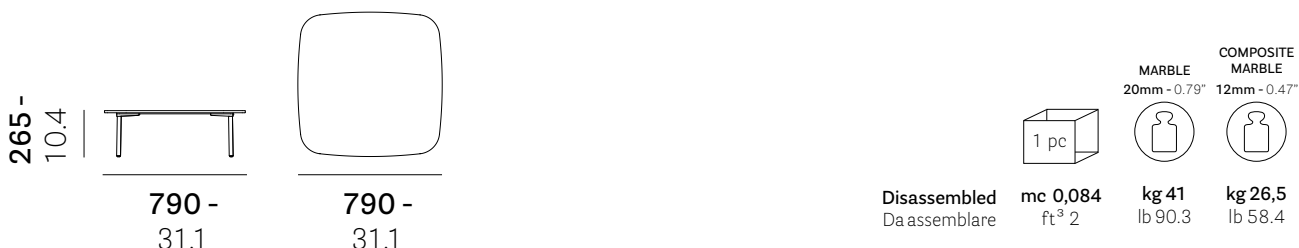

• BDT_79X79X32



EN: Tabletop in marble or composite marble with a compact laminate support 6 mm thickness
IT: Ripiano in marmo e agglomerato di marmo con supporto in stratificato spessore 6 mm



Reproduction of this document is strictly prohibited without prior written authorisation from Pedrali Spa. Sizes, weights and finishes may change without previous notice.
 È vietata la riproduzione del seguente documento senza previa autorizzazione scritta da parte di Pedrali Spa. Dimensioni, pesi e finiture possono variare senza alcun preavviso.

ST_BUDDY_BDT_BDTD_2024.0

BDT - BDTD

DESIGN
Busetti Garuti Redaelli

• BDT_89X89X26

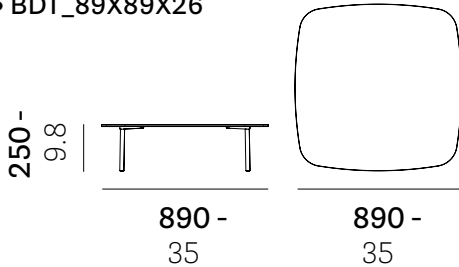

THICKNESS TOP

SOLID LAMINATE
10mm - 0.39"



Disassembled
Da assemblare

mc 0,041
ft³ 2.2

kg 12,7
lb 28

• BDT_89X89X32

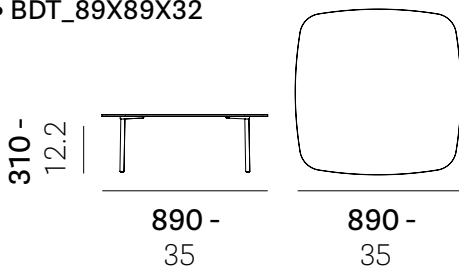

SOLID LAMINATE
10mm - 0.39"



Disassembled
Da assemblare

mc 0,041
ft³ 2.2

kg 13
lb 28.6

• BDT_99X99X26

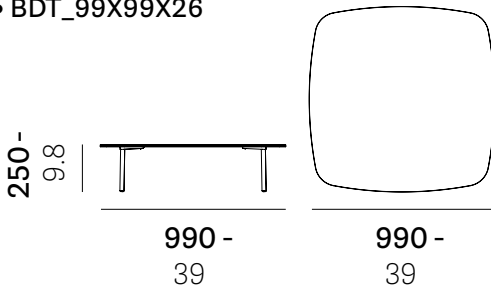

SOLID LAMINATE
10mm - 0.39"



Disassembled
Da assemblare

mc 0,072
ft³ 2.5

kg 15,4
lb 34

• BDT_99X99X32



SOLID LAMINATE
10mm - 0.39"



Disassembled
Da assemblare

mc 0,072
ft³ 2.5

kg 15,6
lb 34.3

• BDT_109X109X26

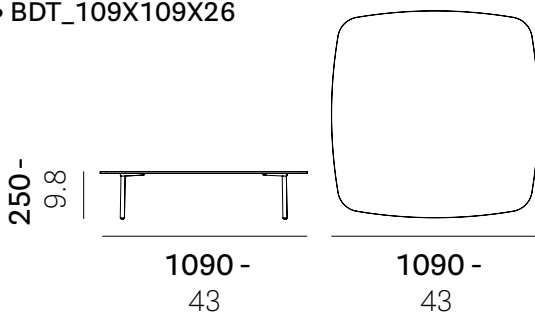

SOLID LAMINATE
10mm - 0.39"



Disassembled
Da assemblare

mc 0,082
ft³ 2.9

kg 18,3
lb 40.3

Reproduction of this document is strictly prohibited without prior written authorisation from Pedrali SpA. Sizes, weights and finishes may change without previous notice.
 È vietata la riproduzione del seguente documento senza previa autorizzazione scritta da parte di Pedrali SpA. Dimensioni, pesi e finiture possono variare senza alcun preavviso.

ST_BUDDY_BDT_BDTD_2024.0

BDT - BDTD

DESIGN
Busetti Garuti Redaelli

• BDT_109X109X32

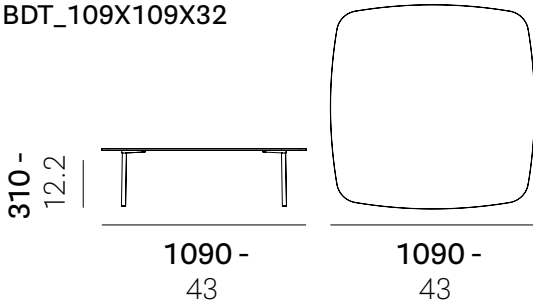

THICKNESS TOP

SOLID LAMINATE
10mm - 0.39"



Disassembled
Da assemblare

mc 0,082
ft³ 2.9

kg 18,5
lb 40.7

• BDT_119X119X26

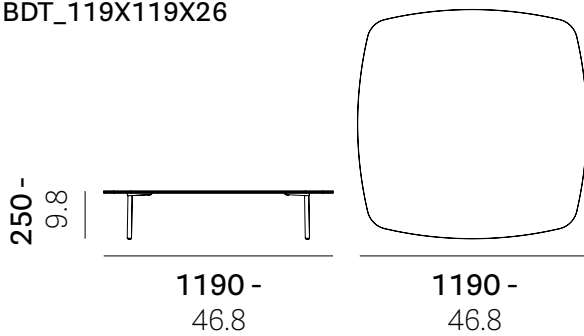

SOLID LAMINATE
10mm - 0.39"



Disassembled
Da assemblare

mc 0,093
ft³ 3.2

kg 21,6
lb 47.6

• BDT_119X119X32

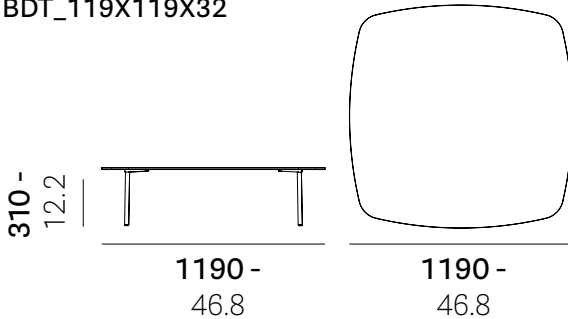

SOLID LAMINATE
10mm - 0.39"



Disassembled
Da assemblare

mc 0,093
ft³ 3.2

kg 21,8
lb 48

• BDT_79X40X26

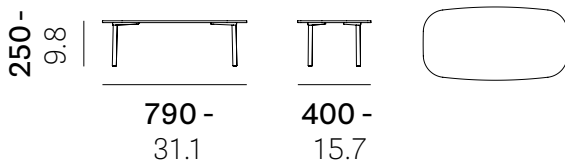

SOLID LAMINATE
10mm - 0.39"



Disassembled
Da assemblare

mc 0,04
ft³ 1.4

kg 6
lb 13.2

• BDT_79X40X32

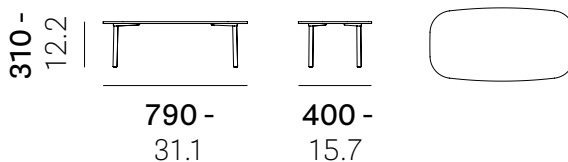

SOLID LAMINATE
10mm - 0.39"



Disassembled
Da assemblare

mc 0,04
ft³ 1.4

kg 6,2
lb 13.6

Reproduction of this document is strictly prohibited without prior written authorisation from Pedrali Spa. Sizes, weights and finishes may change without previous notice. È vietata la riproduzione del seguente documento senza previa autorizzazione scritta da parte di Pedrali Spa. Dimensioni, pesi e finiture possono variare senza alcun preavviso.

ST_BUDDY_BDT_BDTD_2024.0

BDT - BDTD

DESIGN
Busetti Garuti Redaelli

• BDT_120X59X26



THICKNESS TOP

SOLID LAMINATE
10mm - 0.39"

1 pc

Disassembled
Da assemblare

mc 0,059
ft³ 2

kg 11,7
lb 25.7

• BDT_120X59X32



SOLID LAMINATE
10mm - 0.39"

1 pc

Disassembled
Da assemblare

mc 0,059
ft³ 2

kg 11,9
lb 26.2

• BDTD_79X26

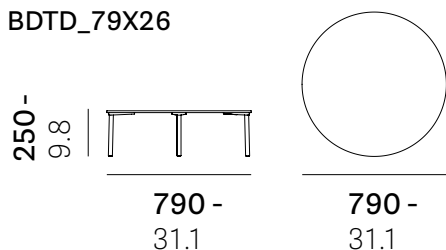

SOLID LAMINATE
10mm - 0.39"

1 pc

Disassembled
Da assemblare

mc 0,054
ft³ 1.9

kg 8,7
lb 19

• BDTD_79X32

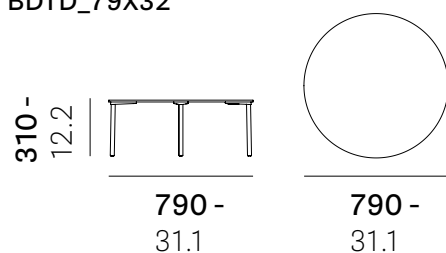

SOLID LAMINATE
10mm - 0.39"

1 pc

Disassembled
Da assemblare

mc 0,054
ft³ 1.9

kg 8,9
lb 19.6

• BDTD_89X26

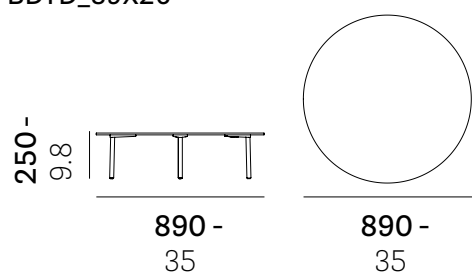

SOLID LAMINATE
10mm - 0.39"

1 pc

Disassembled
Da assemblare

mc 0,062
ft³ 2.1

kg 10,6
lb 23.3

Reproduction of this document is strictly prohibited without prior written authorisation from Pedrali SpA. Sizes, weights and finishes may change without previous notice.
 È vietata la riproduzione del seguente documento senza previa autorizzazione scritta da parte di Pedrali SpA. Dimensioni, pesi e finiture possono variare senza alcun preavviso.

ST_BUDDY_BDT_BDTD_2024.0

BDT - BDTD

DESIGN
Busetti Garuti Redaelli

• BDTD_89X32

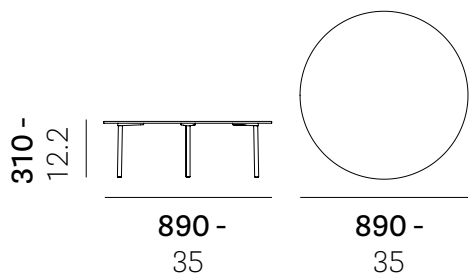

THICKNESS TOP

SOLID LAMINATE
10mm - 0.39"

1 pc

Disassembled
Da assemblare

mc 0,062
ft³ 2.1

kg 10,8
lb 23.8

• BDTD_99X26

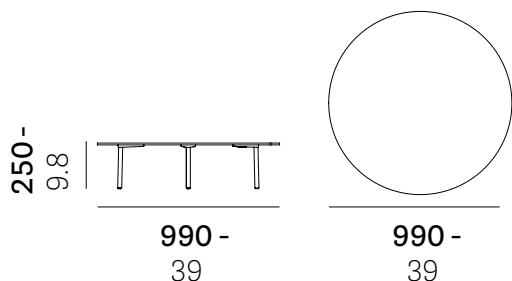

SOLID LAMINATE
10mm - 0.39"

1 pc

Disassembled
Da assemblare

mc 0,071
ft³ 2.5

kg 12,7
lb 28

• BDTD_99X32

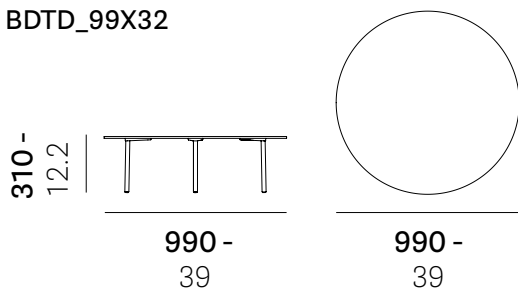

SOLID LAMINATE
10mm - 0.39"

1 pc

Disassembled
Da assemblare

mc 0,071
ft³ 2.5

kg 12,9
lb 28.4

Reproduction of this document is strictly prohibited without prior written authorisation from Pedrali SpA. Sizes, weights and finishes may change without previous notice.
È vietata la riproduzione del seguente documento senza previa autorizzazione scritta da parte di Pedrali SpA. Dimensioni, pesi e finiture possono variare senza alcun preavviso.

ST_BUDDY_BDT_BDTD_2024.0

MATERIALS

Materiali
Materialien
Matériaux
Materiales

• TOP - RIPIANO - TISCHPLATTE - PLATEAU - SOBRE

EN: Solid laminate top
IT: Ripiano in stratificato
DE: Kompakt-Tischplatte
FR: Plateau stratifiés
ES: Sobre compacto

TOP FINISH - FINITURA RIPIANO - AUSFÜHRUNG DER TISCHPLATTE - FINITION PLATEAU - ACABADO SOBRE

TOP / RIPIANO / TISCHPLATTE / PLATEAU / SOBRE
10 mm thickness / Spessore 10 mm / Stärke 10 mm / Épaisseur 10 mm / Espesor 10 mm
Flat edge / Bordo piatto / Flache Kante / Chant plat / Canto rec
White core / Anima bianca / Weißer Kern / Coeur blanc / Alma blanco



CFC_BI

TOP / RIPIANO / TISCHPLATTE / PLATEAU / SOBRE
10 mm thickness / Spessore 10 mm / Stärke 10 mm / Épaisseur 10 mm / Espesor 10 mm
Flat edge / Bordo piatto / Flache Kante / Chant plat / Canto rect
Matching core / Anima in tinta / Entsprechend kern / Coeur en conséquence / Alma en cosecuencia

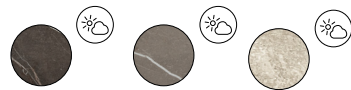

CFP_3445

CFP_3447

CFP_547

TOP / RIPIANO / TISCHPLATTE / PLATEAU / SOBRE
10 mm thickness / Spessore 10 mm / Stärke 10 mm / Épaisseur 10 mm / Espesor 10 mm
Flat edge / Bordo piatto / Flache Kante / Chant plat / Canto rect
Black core / Anima nera / Schwarzer kern / Coeur noir / Alma negra



FNP_NE*

FNP_3452*

***Anti-fingerprint finish**
Finitura anti-impronta

TOP / RIPIANO / TISCHPLATTE / PLATEAU / SOBRE
10 mm thickness / Spessore 10 mm / Stärke 10 mm / Épaisseur 10 mm / Espesor 10 mm
Flat edge / Bordo piatto / Flache Kante / Chant plat / Canto rect
White core / Anima bianca / Weißer Kern / Coeur blanc / Alma blanco



FNP_3455*

***Anti-fingerprint finish**
Finitura anti-impronta

TOP / RIPIANO / TISCHPLATTE / PLATEAU / SOBRE
10 mm thickness / Spessore 10 mm / Stärke 10 mm / Épaisseur 10 mm / Espesor 10 mm
Flat edge / Bordo piatto / Flache Kante / Chant plat / Canto rect
Matching edge / Anima in tinta / Kern aus gleicher Farbe / Chant assorti / Canto a juego

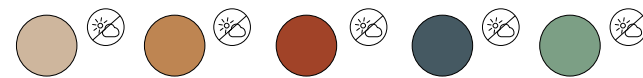

FNP_0719*

FNP_0791*

FNP_0789*

FNP_0792*

FNP_0773*

***Anti-fingerprint finish**
Finitura anti-impronta

TOP / RIPIANO / TISCHPLATTE / PLATEAU / SOBRE
10 mm thickness / Spessore 10 mm / Stärke 10 mm / Épaisseur 10 mm / Espesor 10 mm
Flat edge / Bordo piatto / Flache Kante / Chant plat / Canto rect
Brown core / Anima marrone / Schwarzer Marone / Coeur marron / Alma marrón



COP_4543

COP_4519

TOP / RIPIANO / TISCHPLATTE / PLATEAU / SOBRE
10 mm thickness / Spessore 10 mm / Stärke 10 mm / Épaisseur 10 mm / Espesor 10 mm
Flat edge / Bordo piatto / Flache Kante / Chant plat / Canto rect
Black core / Anima nera / Schwarzer kern / Coeur noir / Alma negra



TOP / RIPIANO / TISCHPLATTE / PLATEAU / SOBRE
10 mm thickness / Spessore 10 mm / Stärke 10 mm / Épaisseur 10 mm / Espesor 10 mm
Flat edge / Bordo piatto / Flache Kante / Chant plat / Canto rect
Beige core / Anima beige / Beige kern / Coeur beige / Alma beis



TOP / RIPIANO / TISCHPLATTE / PLATEAU / SOBRE
10 mm thickness / Spessore 10 mm / Stärke 10 mm / Épaisseur 10 mm / Espesor 10 mm
Flat edge / Bordo piatto / Flache Kante / Chant plat / Canto rect
Grey core / Anima grigia / Grauer Kern / Coeur gris / Alma gris

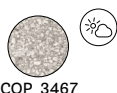

TOP / RIPIANO / TISCHPLATTE / PLATEAU / SOBRE
10 mm thickness / Spessore 10 mm / Stärke 10 mm / Épaisseur 10 mm / Espesor 10 mm
Flat edge / Bordo piatto / Flache Kante / Chant plat / Canto rect
Black core / Anima nera / Schwarzer kern / Coeur noir / Alma negra



• **TOP - RIPIANO - TISCHPLATTE - PLATEAU - SOBRE**

EN: Marble top
 IT: Ripiano in marmo
 DE: Marmor-Tischplatte
 FR: Plateau en marbre
 ES: Sobre de mármol

TOP FINISH - FINITURA RIPIANO - AUSFÜHRUNG DER TISCHPLATTE - FINITION PLATEAU - ACABADO SOBRE



***Matt smoothed**
 Levigato opaco

TOP / RIPIANO / TISCHPLATTE / PLATEAU / SOBRE
20 mm thickness / Spessore 20 mm / Stärke 20 mm / Épaisseur 20 mm / Espesor 20 mm
Flat edge / Bordo piatto / Flache Kante / Chant plat / Canto rec

Reproduction of this document is strictly prohibited without prior written authorisation from Pedrali SpA. Sizes, weights and finishes may change without previous notice.
 È vietata la riproduzione del seguente documento senza previa autorizzazione scritta da parte di Pedrali SpA. Dimensioni, pesi e finiture possono variare senza alcun preavviso.

ST_BUDDY_BDT_BDTD_2024_0

• **TOP - RIPIANO - TISCHPLATTE - PLATEAU - SOBRE**

EN: Compite marble top
IT: Ripiano in agglomerato di marmo
DE: Marmor-Konglomerat
FR: Plateau en marbre aggloméré
ES: Sobre de mármol aglomerado

TOP FINISH - FINITURA RIPIANO - AUSFÜHRUNG DER TISCHPLATTE - FINITION PLATEAU - ACABADO SOBRE

TOP / RIPIANO / TISCHPLATTE / PLATEAU / SOBRE
12 mm thickness / Spessore 12 mm / Stärke 12 mm / Épaisseur 12 mm / Espesor 12 mm
Bevelled edge / Bordo smussato / Abgeschrägte Kante / Chant biseauté / Canto biselado



• **FRAME - TELAIO - STRUKTUR - STRUCTURE - ARMAZÓN**

EN: Aluminium legs, tube Ø22 mm
IT: Gambe in alluminio, tubo Ø22 mm
DE: Aluminiumbeine, Rohr Ø22 mm
FR: Jambes en aluminium, tube Ø22 mm
ES: Patas de aluminio, tubo Ø22 mm

FINISH - FINITURA - AUSFÜHRUNG - FINITION - ACABADO

EN: Powder coating
IT: Verniciato con polvere
DE: Pulverbeschichtet
FR: Époxy à poudre
ES: Barnizado con polvo

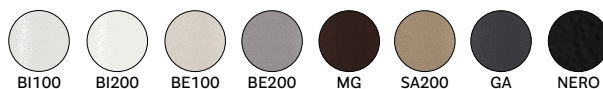

EN: For full range of color available see finishing legend on the website
IT: Per tutta la gamma di colori disponibili vedere legenda finiture sul sito web

EN: Antique brass
IT: Ottone anticato
DE: Messing Antik
FR: Laiton vieilli
ES: Latón antiguo



EN: Titanium
IT: Titanio
DE: Titan
FR: Titane
ES: Titanio



***EN: Only for Buddy with marble and composite marble top**
IT: Solo per Buddy con ripiano in marmo e in agglomerato di marmo

EN: Powder coating for outdoor
 IT: Verniciato a polvere per esterno
 DE: Pulverbeschichtet für den Außenbereich
 FR: Époxy à poudre pour extérieur
 ES: Barnizado en polvo para uso exterior



EN: For full range of color available see finishing legend on the website
 IT: Per tutta la gamma di colori disponibili vedere legenda finiture sul sito web

• FEET - PIEDINI - GLEITER - PATINS - TACOS

EN: Ø18 mm polyethylene pads, black
 IT: Gommini in polietilene, Ø18 mm, nero
 DE: Ø18 mm Polyethylen-Pads, schwarz
 FR: Caoutchouc en polyéthylène Ø18 mm, noir
 ES: Goma de polietileno Ø18 mm, negro

REGULATIONS AND CERTIFICATES

Normative e Certificazioni
 Bestimmungen und Zertifikat
 Normatives et certifications
 Normativas y certificados

• ENVIRONMENTAL IMPACT - IMPATTO AMBIENTALE - UMWELTBELASTUNG - IMPACT SUR L'ENVIRONNEMENT - IMPACTO AMBIENTAL

MATERIAL Materiale	WEIGHT (Kg) Peso (Kg)	% ON TOTAL ITEM % su tot articolo	MATERIAL RECYCLABILITY Riciclabilità del materiale	% RECYCLED AT ORIGIN % riciclato all'origine	% RECYCLABLE END OF PRODUCT LIFE % riciclabile fine vita prodotto
Steel Acciaio	0,024	0,4	YES	33,2	100
Extruded Aluminium Estruso di alluminio	0,9	15	YES	100	100
Die-cast aluminium Alluminio pressofuso	0,6	10	YES	94	100
Polyethylene Polietilene	0,005	0,1	YES	0	100
Solid Laminate Stratificato	4,5	74,6	NO	0	0
TOTAL TOTALE	6 Kg	--	--	24,4 %	25,4 %

EN: Percentages referred to BDT_79X40X26 (Solid Laminate)
 IT: Percentuali riferite al BDT_79X40X26 (Stratificato)

Reproduction of this document is strictly prohibited without prior written authorisation from Pedrali SpA. Sizes, weights and finishes may change without previous notice.
 È vietata la riproduzione del seguente documento senza previa autorizzazione scritta da parte di Pedrali SpA. Dimensioni, pesi e finiture possono variare senza alcun preavviso.